

25 Dot-to-Dot Puzzles for Kids

Free

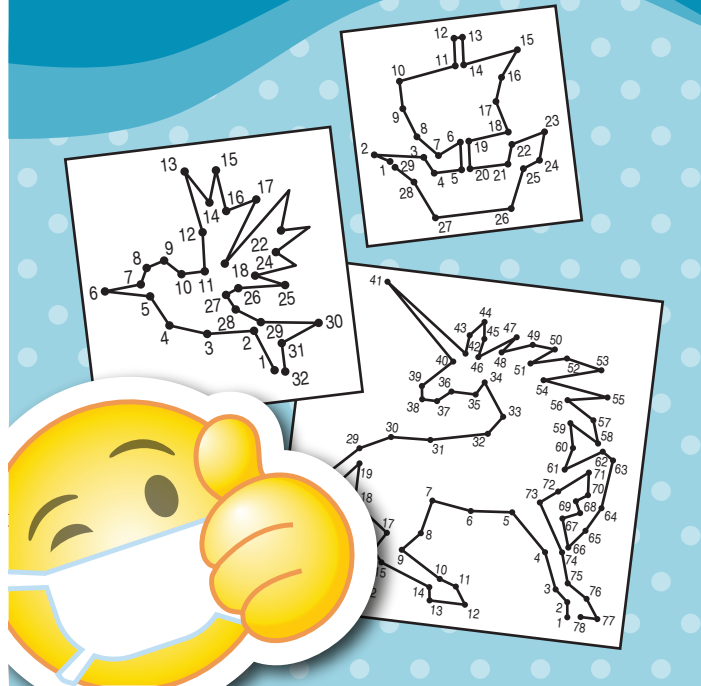

25 Dot-to-Dot Puzzles for Kids

Dear parents and puzzlers,

As many of us continue to face quarantine and school closures, we wanted to create a puzzle book for kids. This print-friendly PDF book has a variety of dot-to-dot puzzles that will help keep their minds focused and hopefully, provide the parents with a tiny bit of quiet!

The Dot-to-Dot puzzles in this book are also available as online games at conceptispuzzles.com as well as mobile apps for iPhone, iPad and Android which offer more free puzzles including new ones published every Friday.

We hope your kids enjoy the puzzles as we make the best of this new reality, and wait for better days.

Stay safe and healthy!

The Conceptis Team

Contents

Puzzles	3-22
Solutions	23-25



More
Conceptis Puzzles
on App Store



More
Conceptis Puzzles
on Google Play

More
Conceptis Puzzles
on conceptispuzzles.com

1

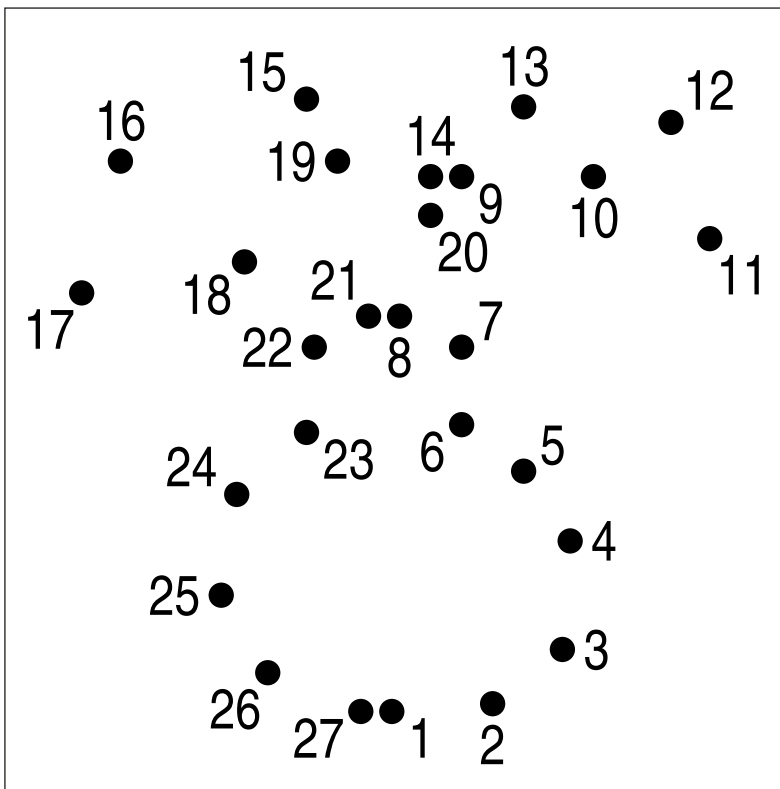

2

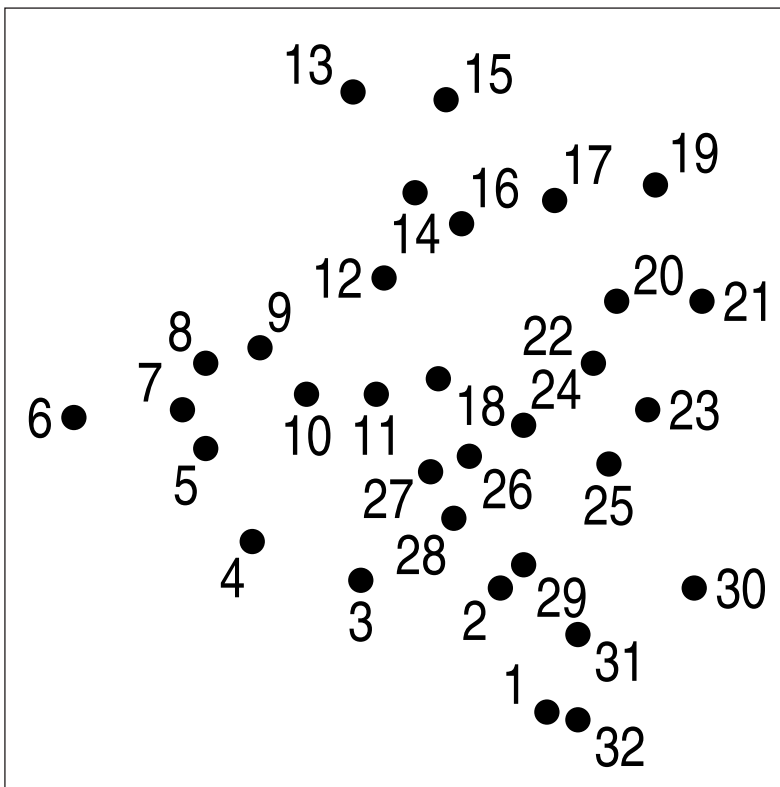

More
Conceptis Puzzles
on App Store



More
Conceptis Puzzles
on Google Play

More
Conceptis Puzzles
on conceptispuzzles.com

3

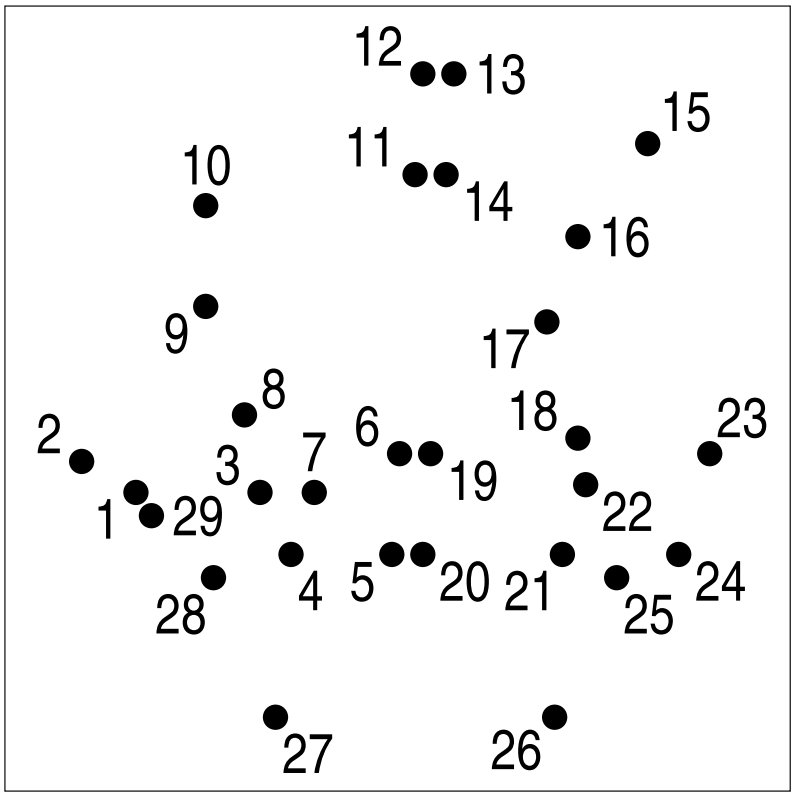

4

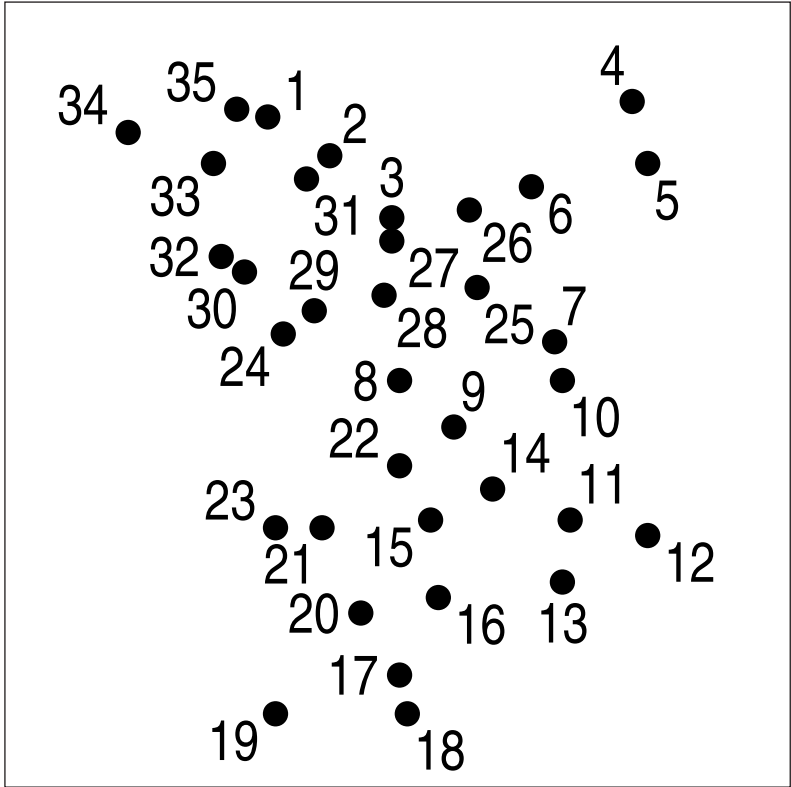

More
Conceptis Puzzles
on App Store



More
Conceptis Puzzles
on Google Play

More
Conceptis Puzzles
on conceptispuzzles.com

5

5

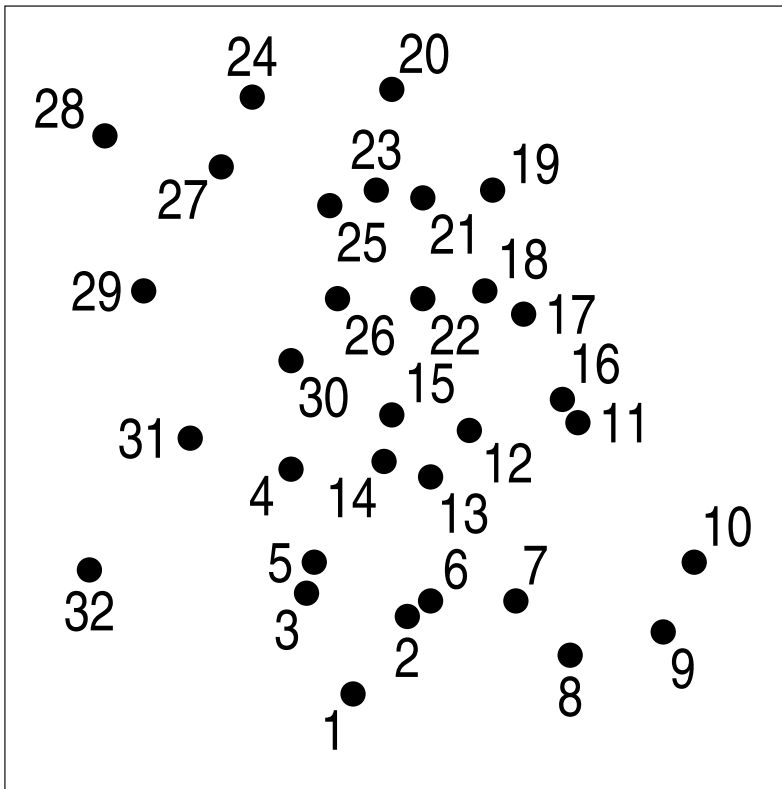

6

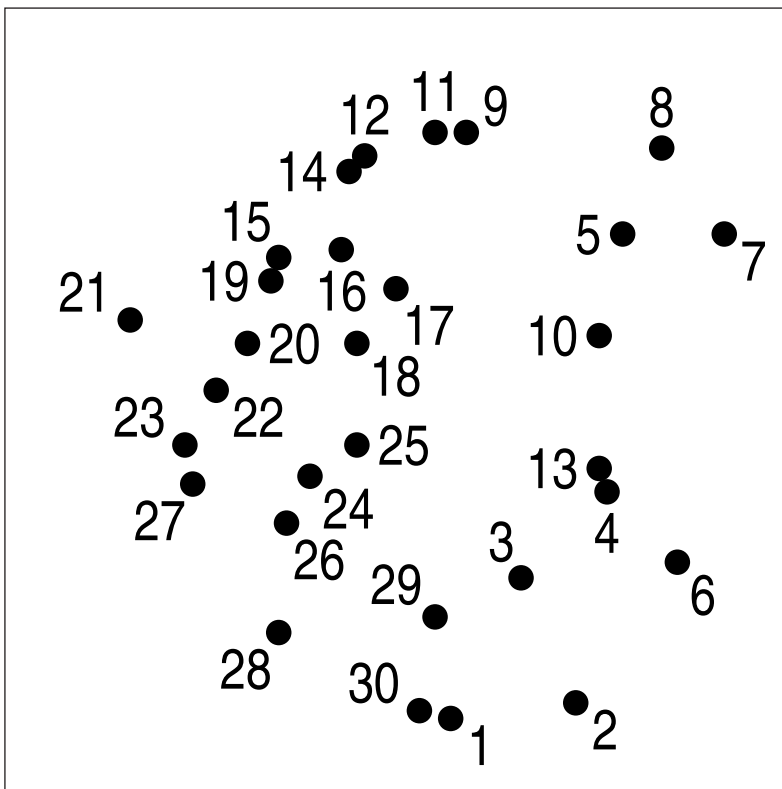

More
Conceptis Puzzles
on App Store



More
Conceptis Puzzles
on Google Play

More
Conceptis Puzzles
on conceptispuzzles.com

7

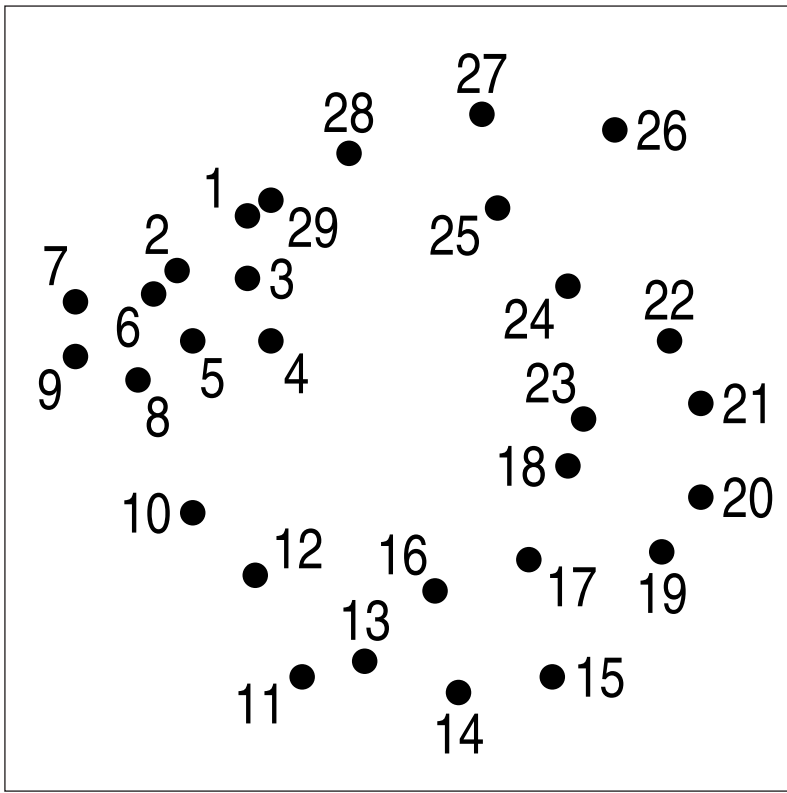

8

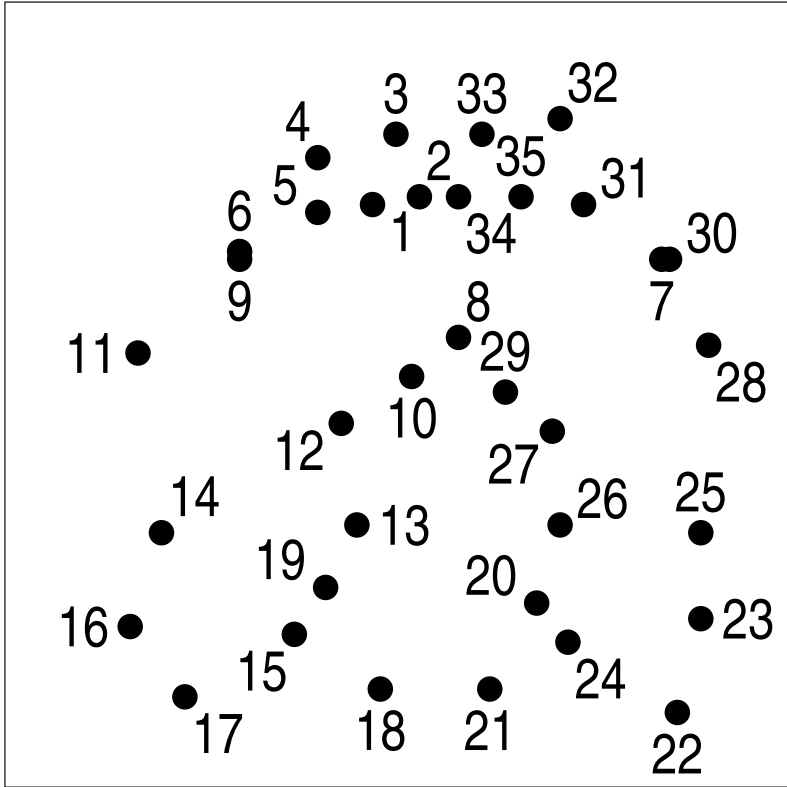

More
Conceptis Puzzles
on App Store



More
Conceptis Puzzles
on Google Play

More
Conceptis Puzzles
on conceptispuzzles.com

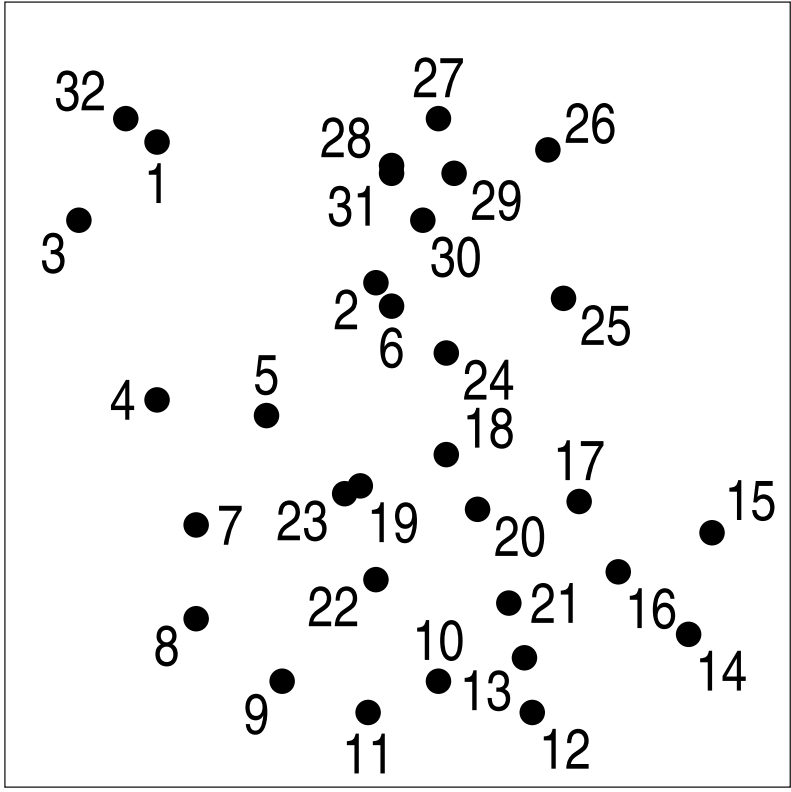
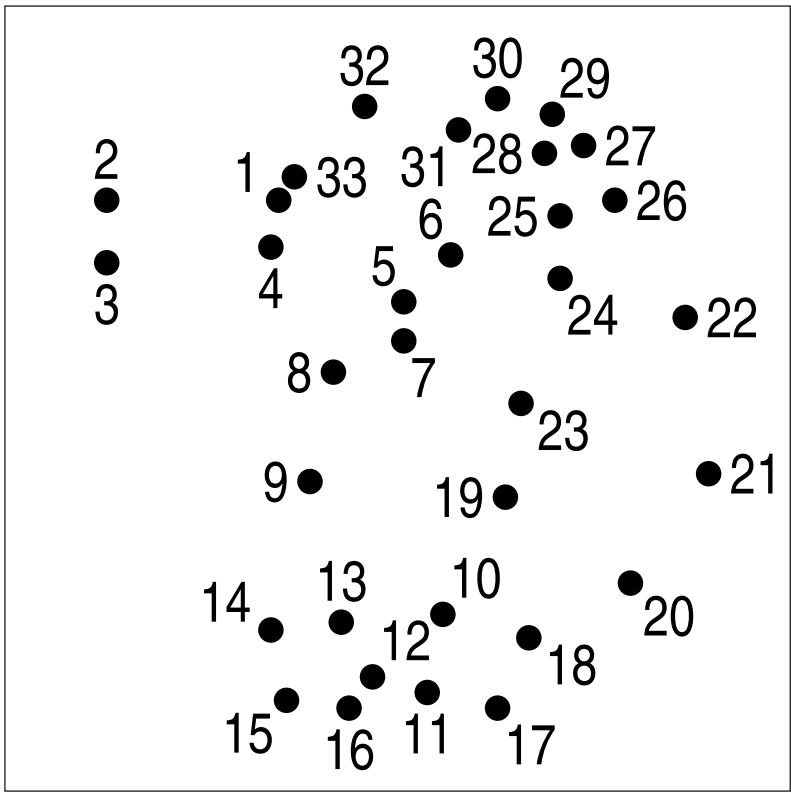

More
Conceptis Puzzles
on App Store



More
Conceptis Puzzles
on Google Play

More
Conceptis Puzzles
on conceptispuzzles.com

11

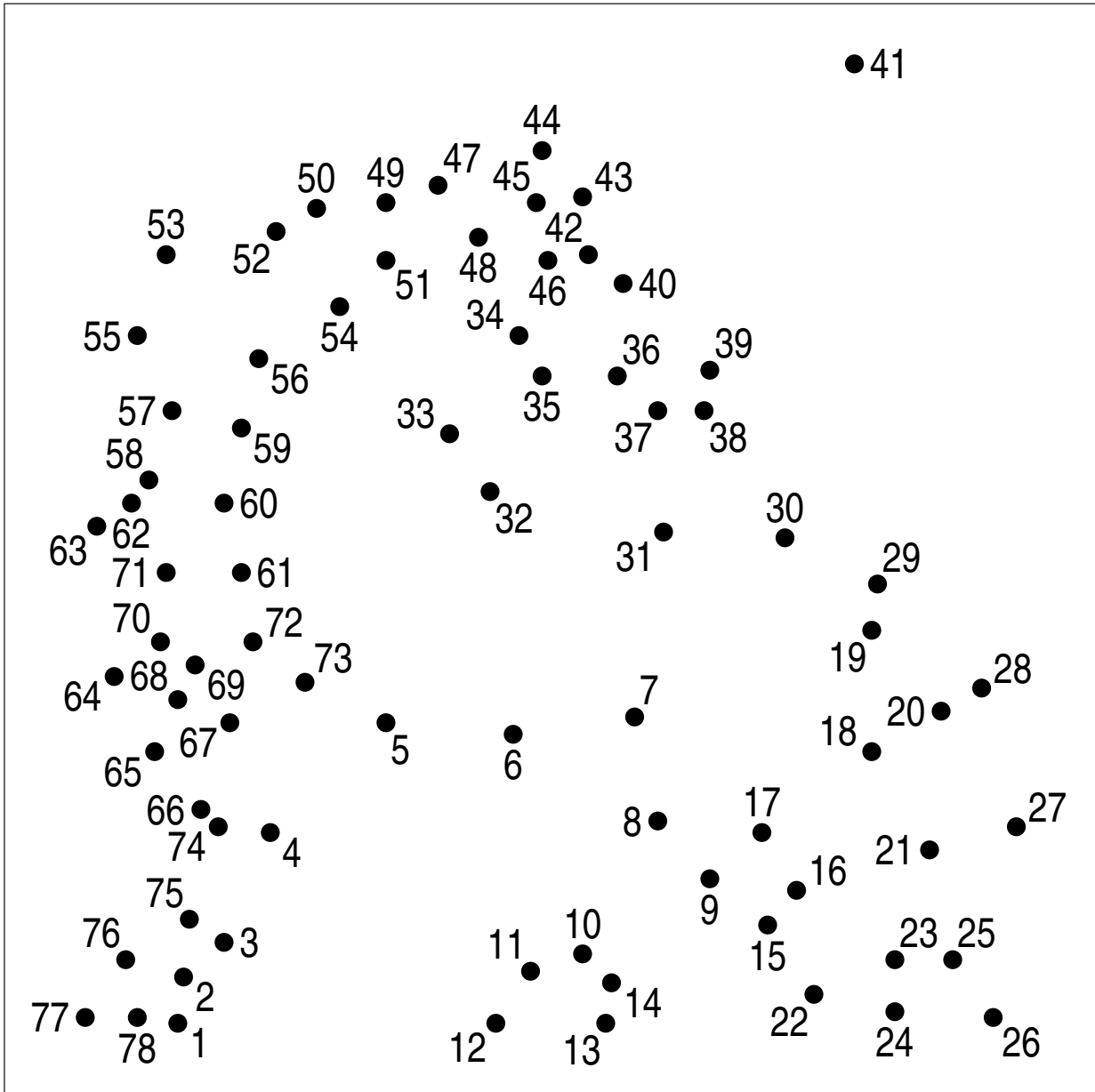

More
Conceptis Puzzles
on App Store



More
Conceptis Puzzles
on Google Play

More
Conceptis Puzzles
on conceptispuzzles.com

12

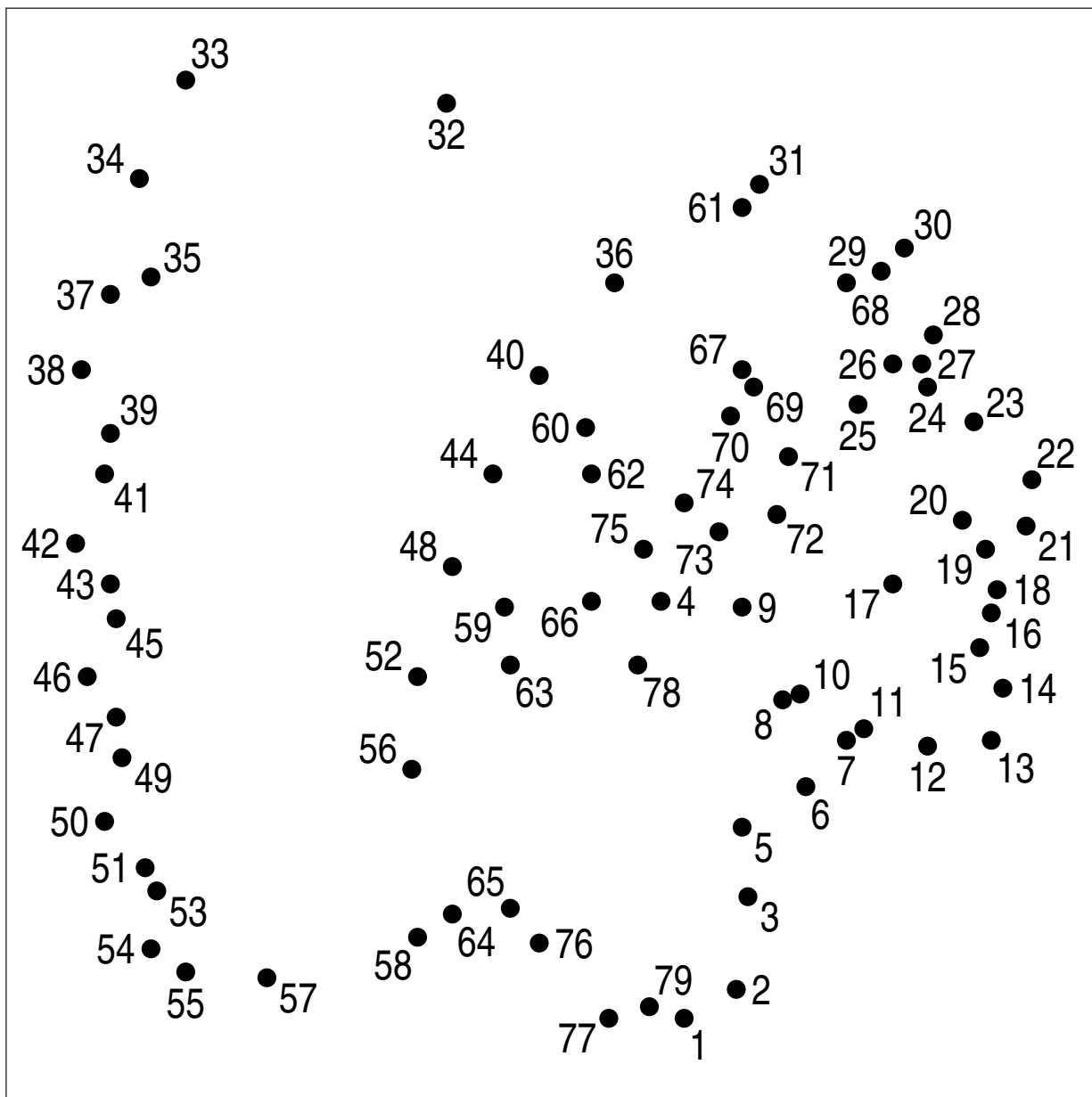

More
Conceptis Puzzles
on App Store



More
Conceptis Puzzles
on Google Play

More
Conceptis Puzzles
on conceptispuzzles.com

13

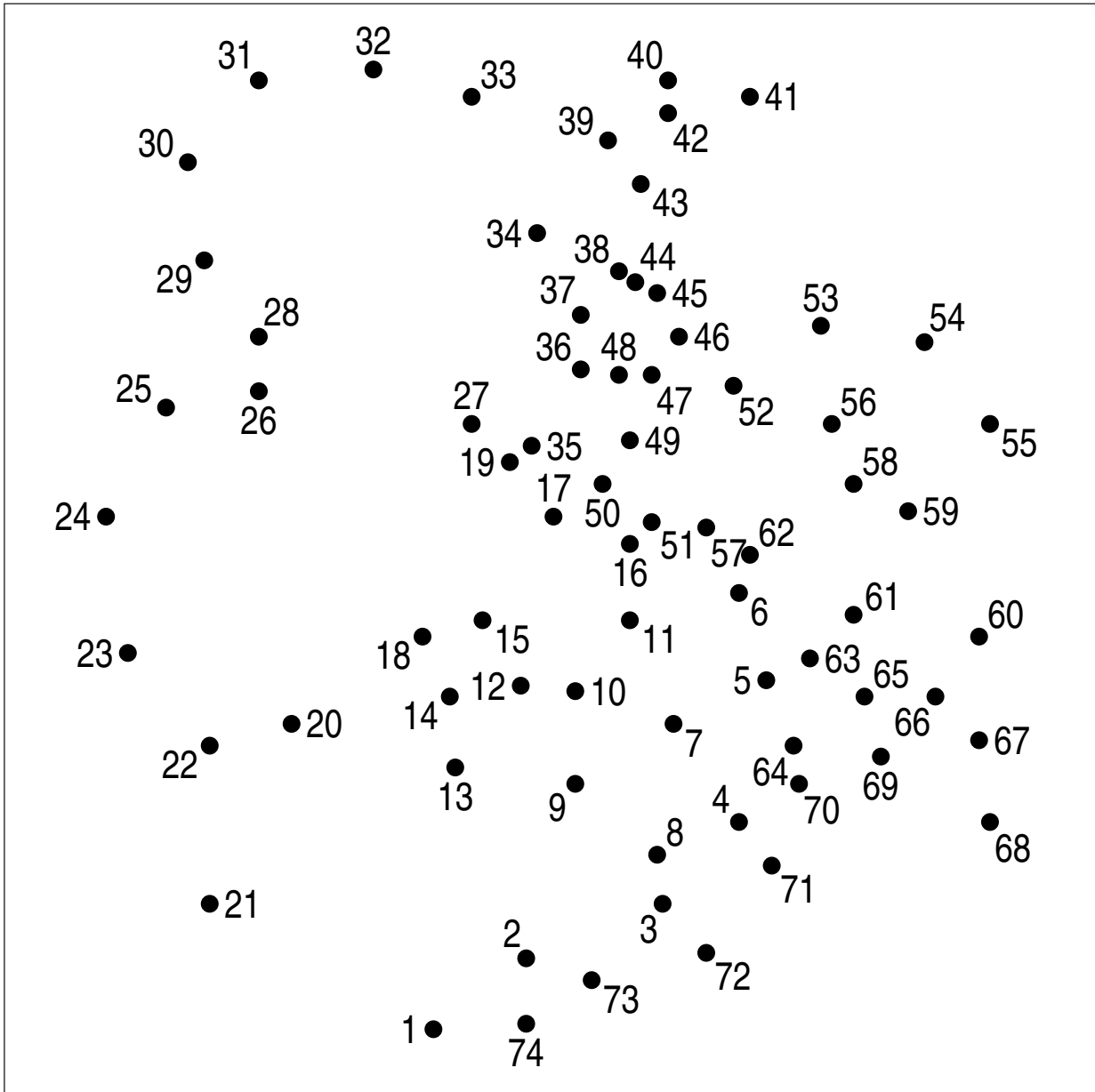

More
Conceptis Puzzles
on App Store



More
Conceptis Puzzles
on Google Play

More
Conceptis Puzzles
on conceptispuzzles.com

14

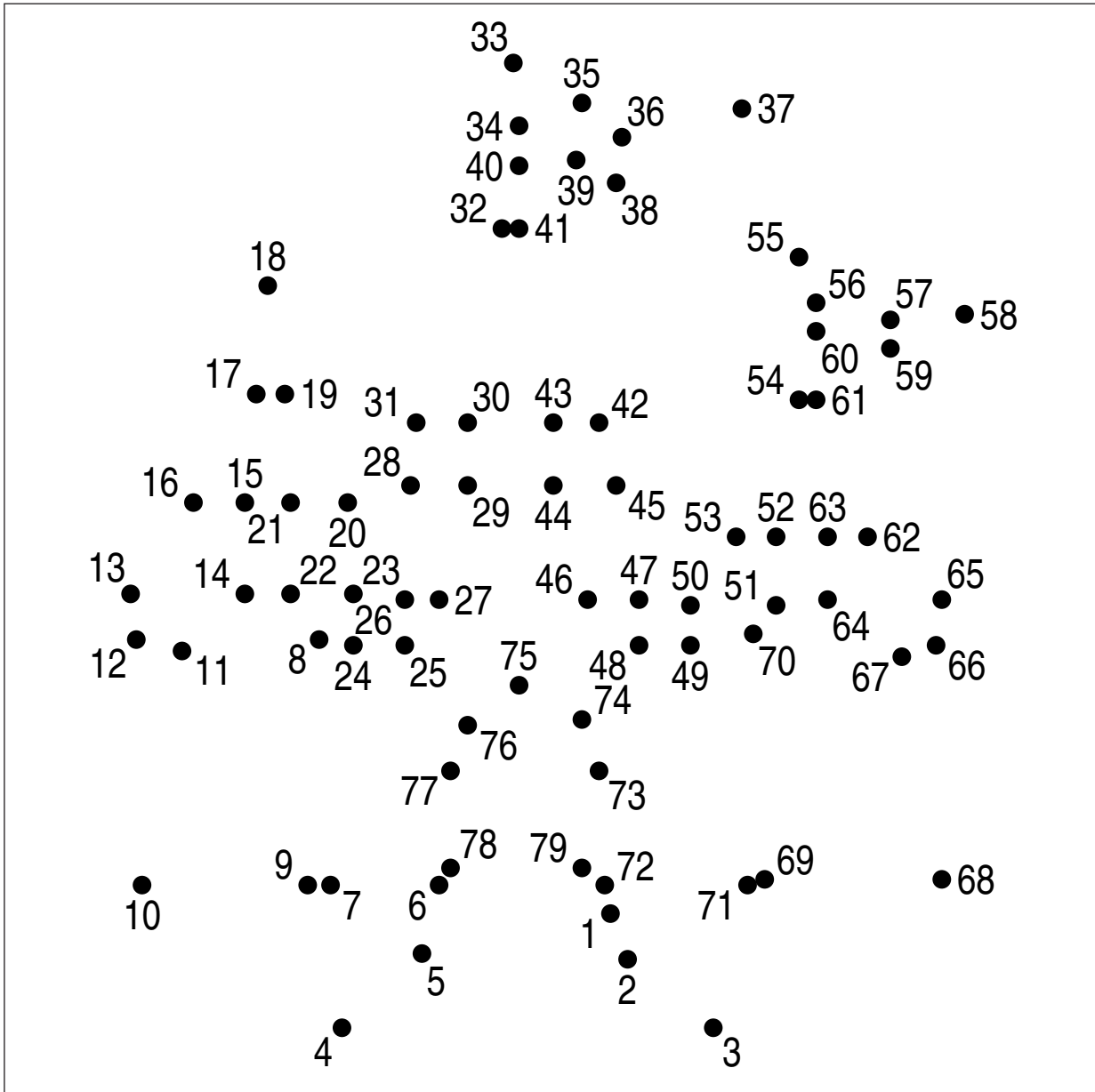

More
Conceptis Puzzles
on App Store



More
Conceptis Puzzles
on Google Play

More
Conceptis Puzzles
on conceptispuzzles.com

15

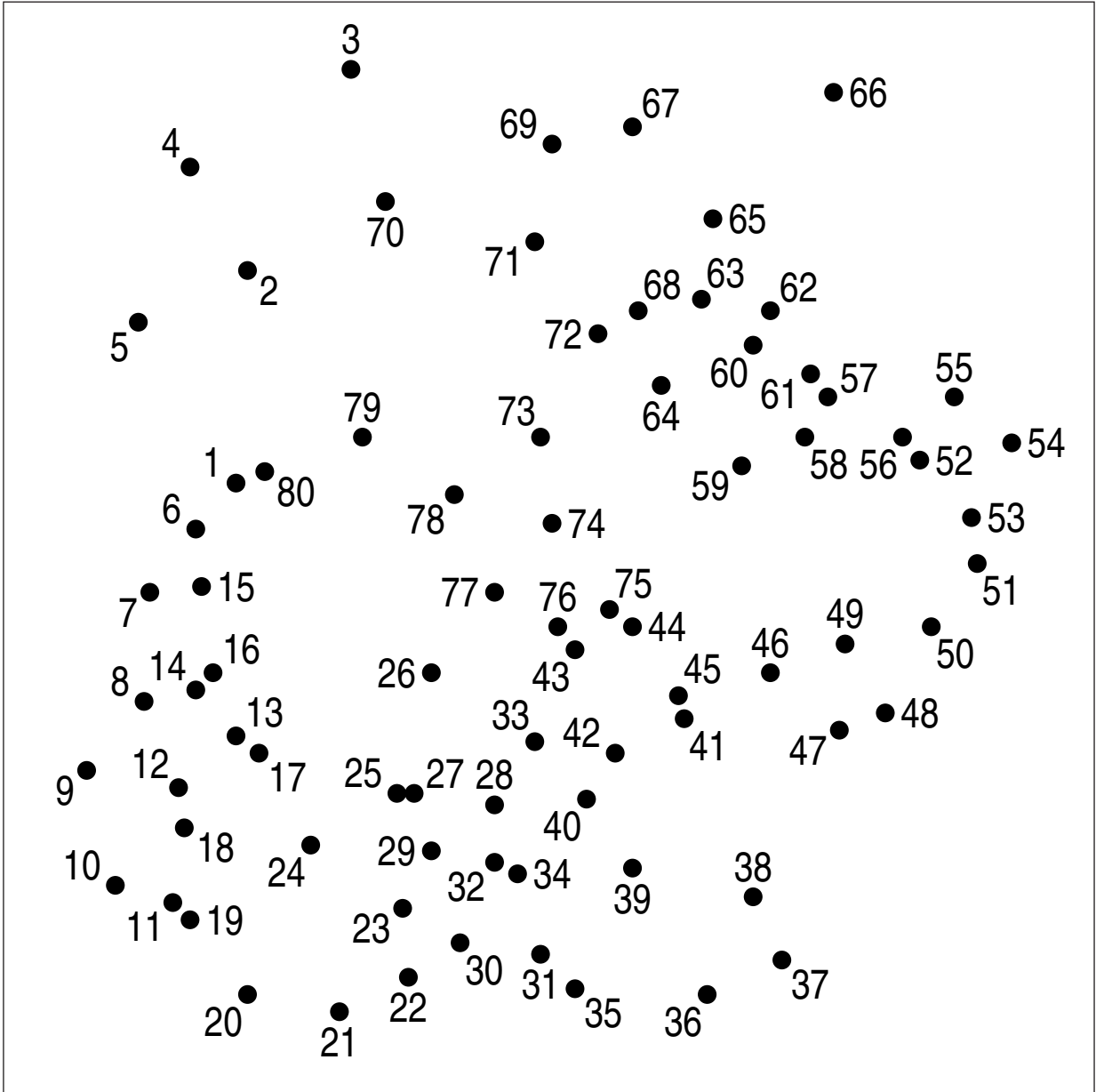

More
Conceptis Puzzles
on App Store



More
Conceptis Puzzles
on Google Play

More
Conceptis Puzzles
on conceptispuzzles.com

16

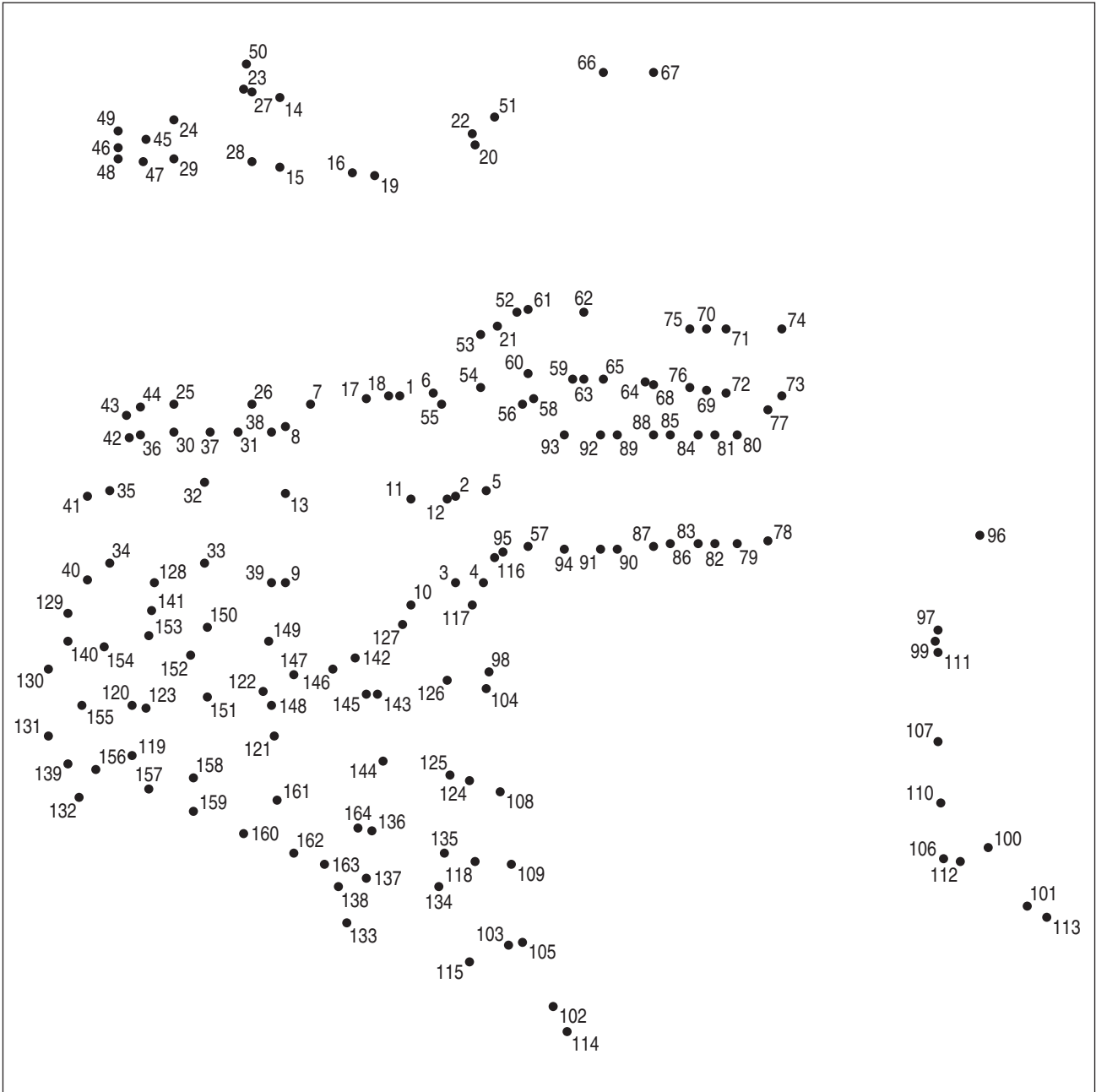

More
Conceptis Puzzles
on App Store



More
Conceptis Puzzles
on Google Play

More
Conceptis Puzzles
on conceptispuzzles.com

17

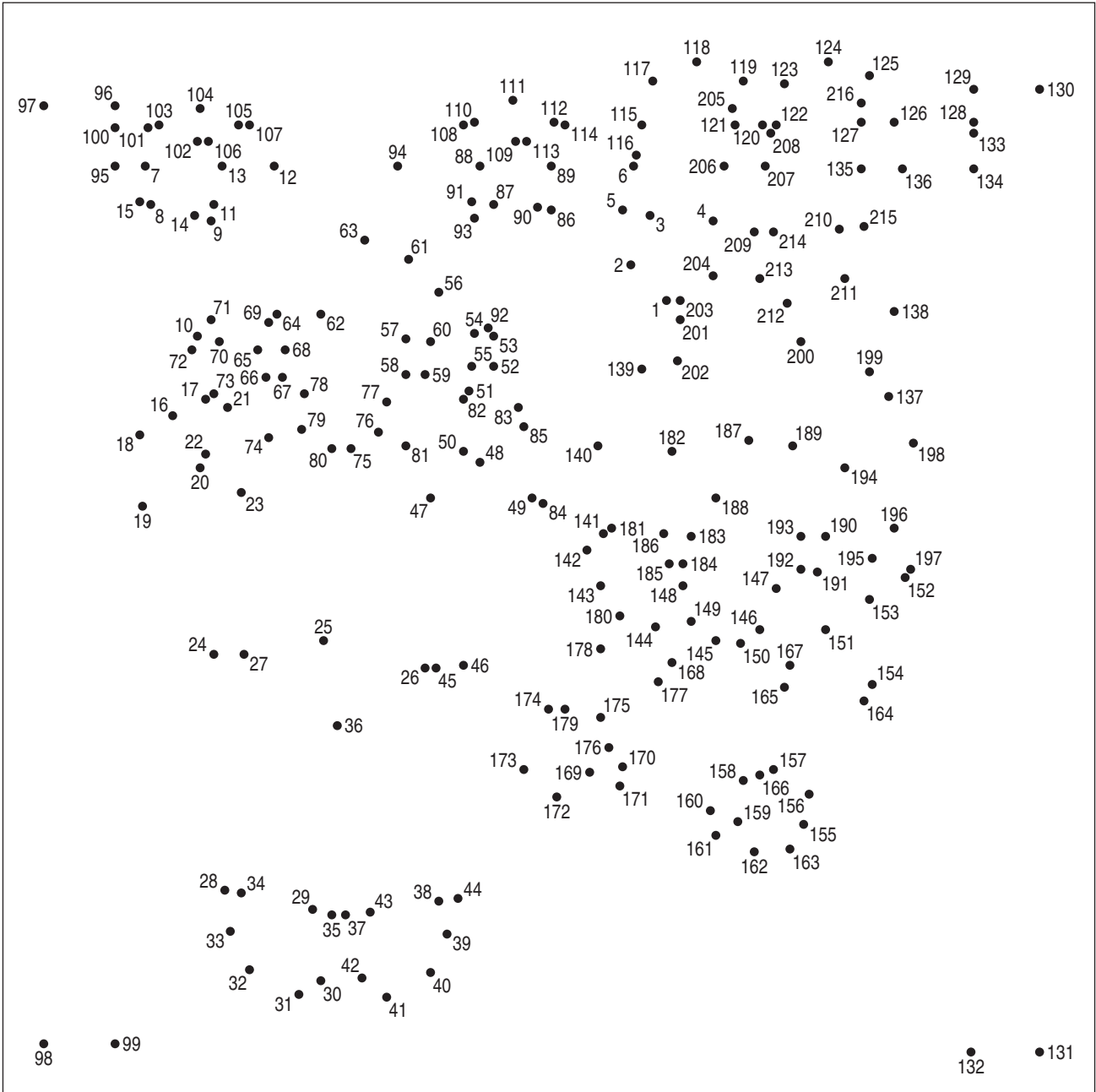

More
Conceptis Puzzles
on App Store



More
Conceptis Puzzles
on Google Play

More
Conceptis Puzzles
on conceptispuzzles.com

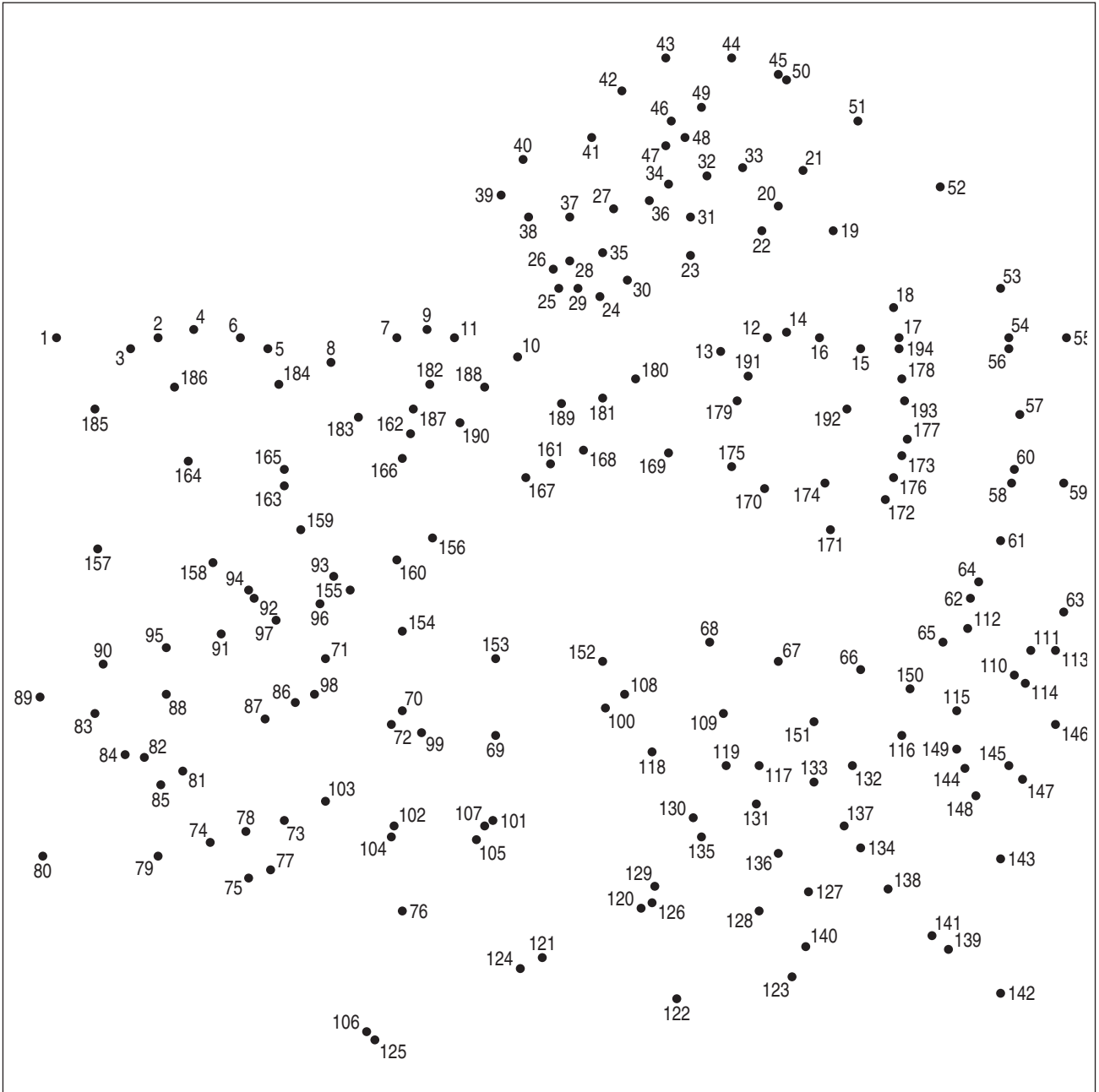

More
Conceptis Puzzles
on App Store



More
Conceptis Puzzles
on Google Play

More
Conceptis Puzzles
on conceptispuzzles.com

19

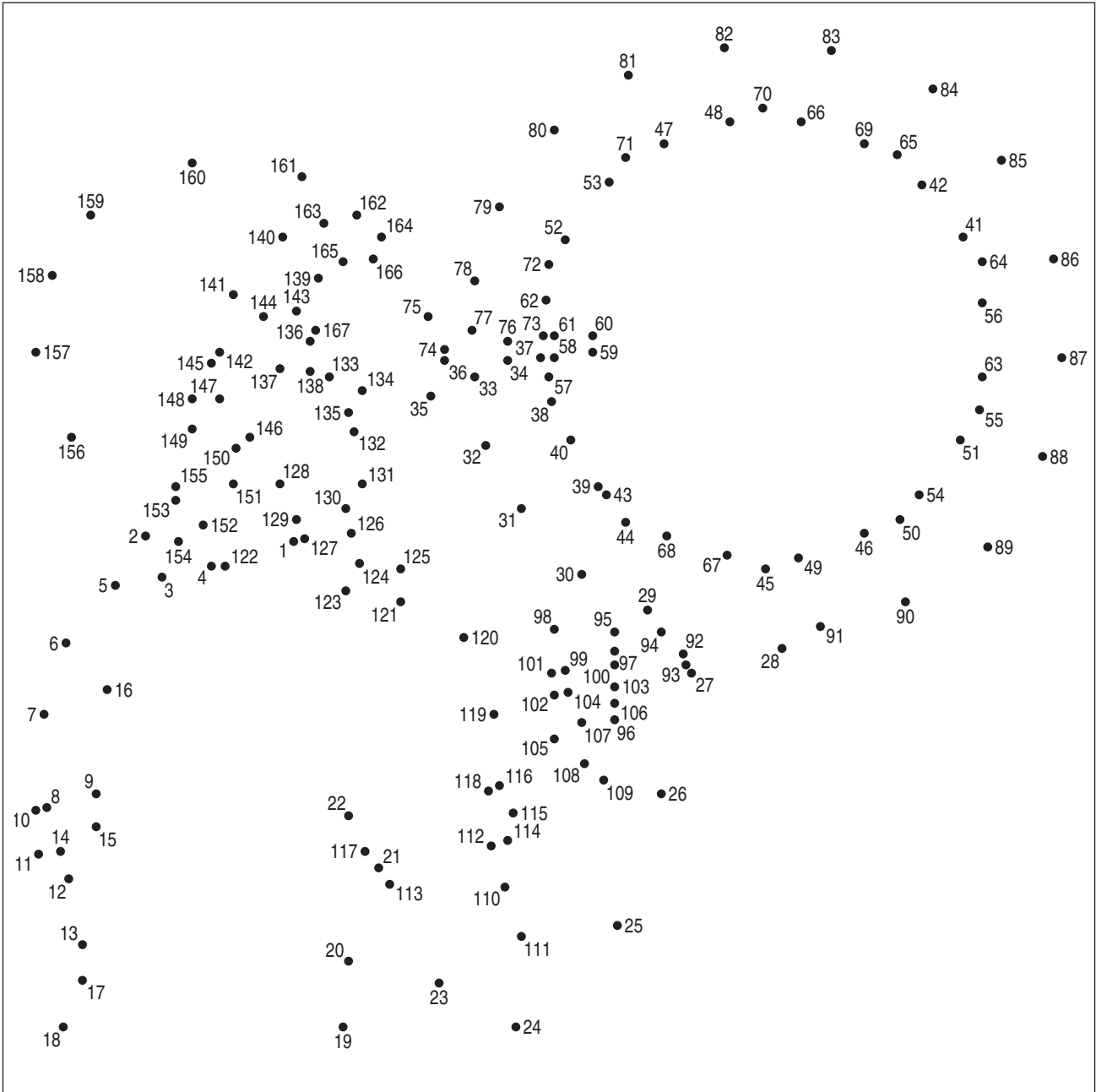

More
Conceptis Puzzles
on App Store



More
Conceptis Puzzles
on Google Play

More
Conceptis Puzzles
on conceptispuzzles.com

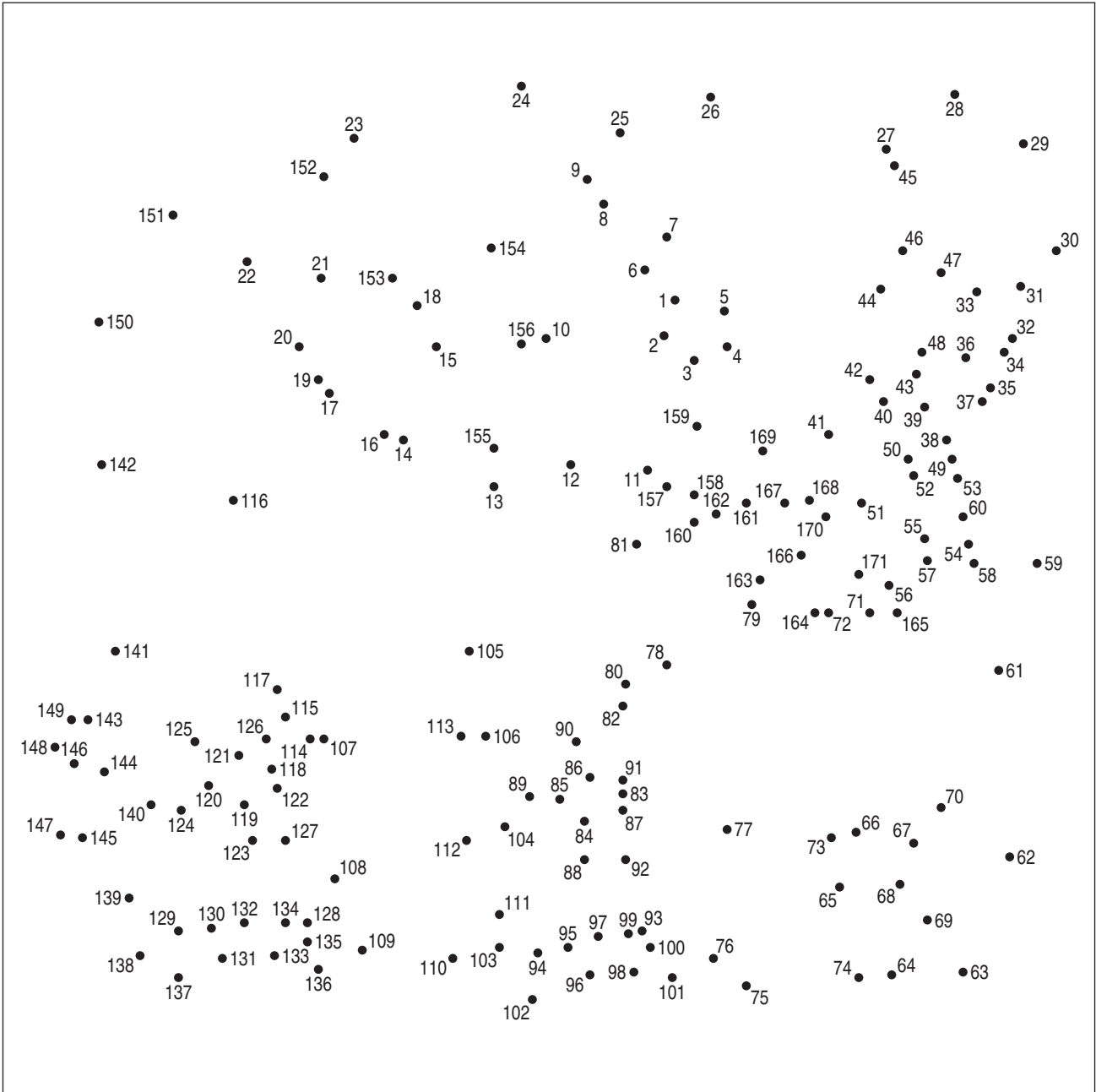

More
Conceptis Puzzles
on App Store



More
Conceptis Puzzles
on Google Play

More
Conceptis Puzzles
on conceptispuzzles.com

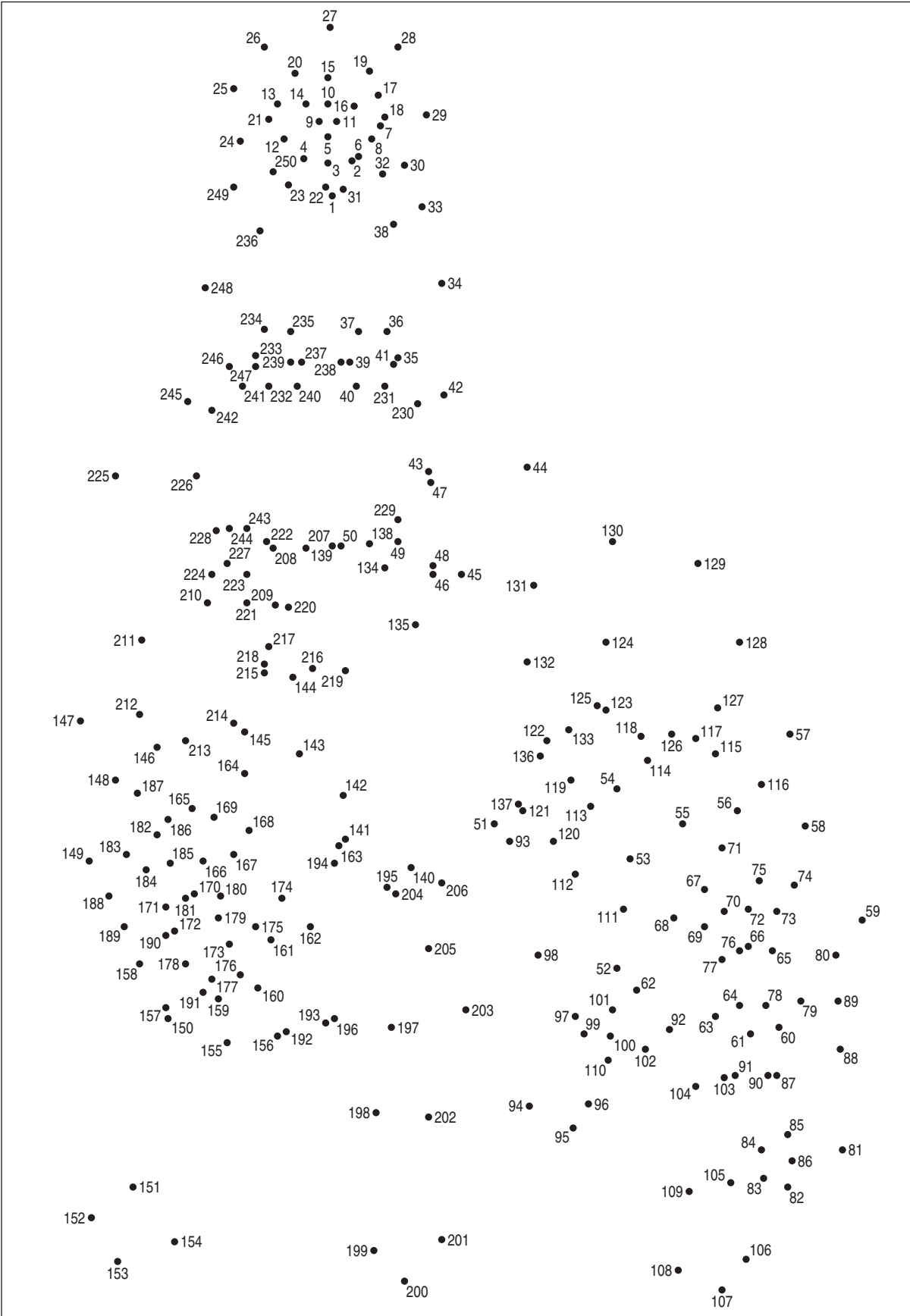

More
Conceptis Puzzles
on App Store



More
Conceptis Puzzles
on Google Play

More
Conceptis Puzzles
on conceptispuzzles.com

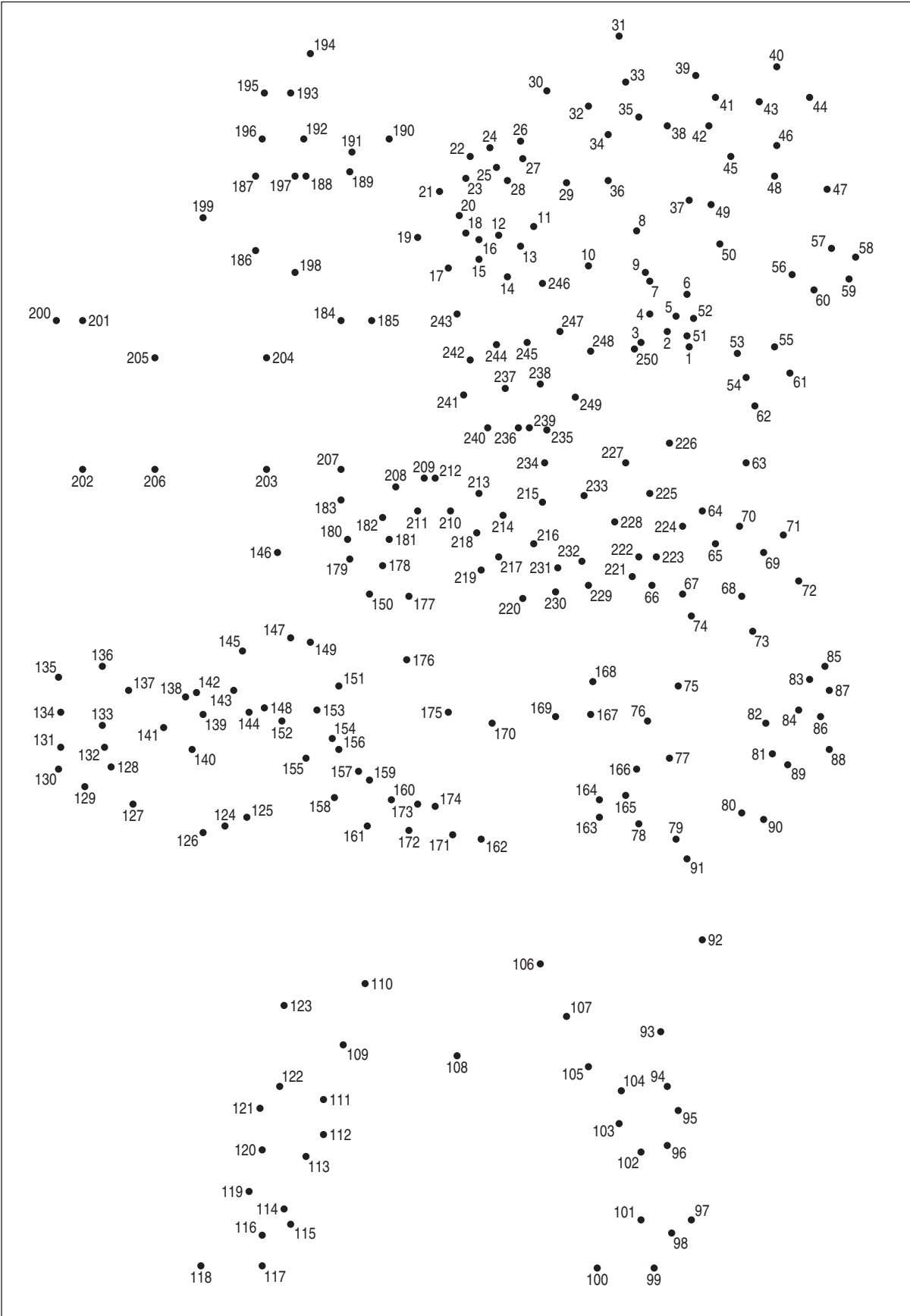

More
Conceptis Puzzles
on App Store



More
Conceptis Puzzles
on Google Play

More
Conceptis Puzzles
on conceptispuzzles.com

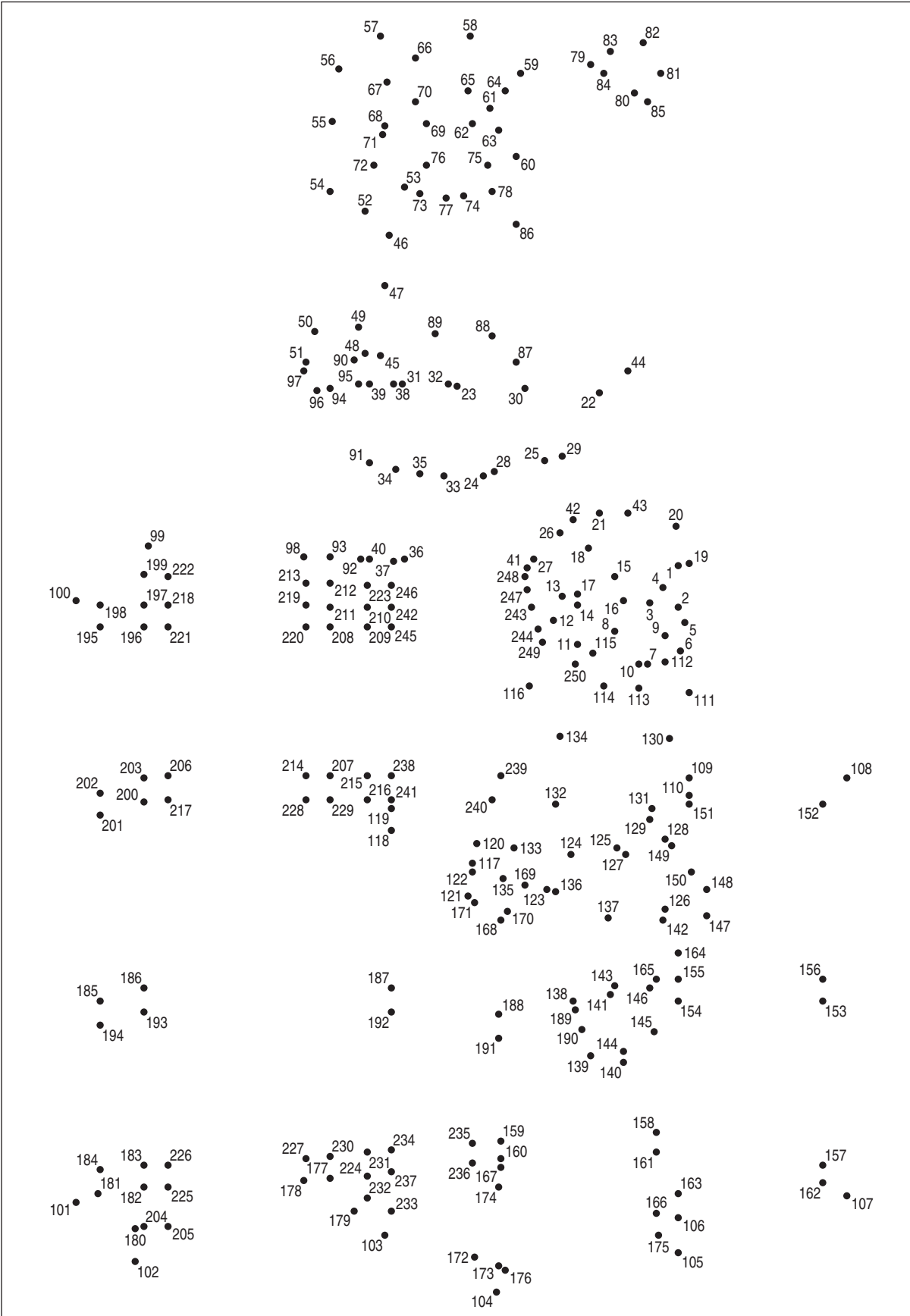

More
Conceptis Puzzles
on App Store



More
Conceptis Puzzles
on Google Play

More
Conceptis Puzzles
on conceptispuzzles.com

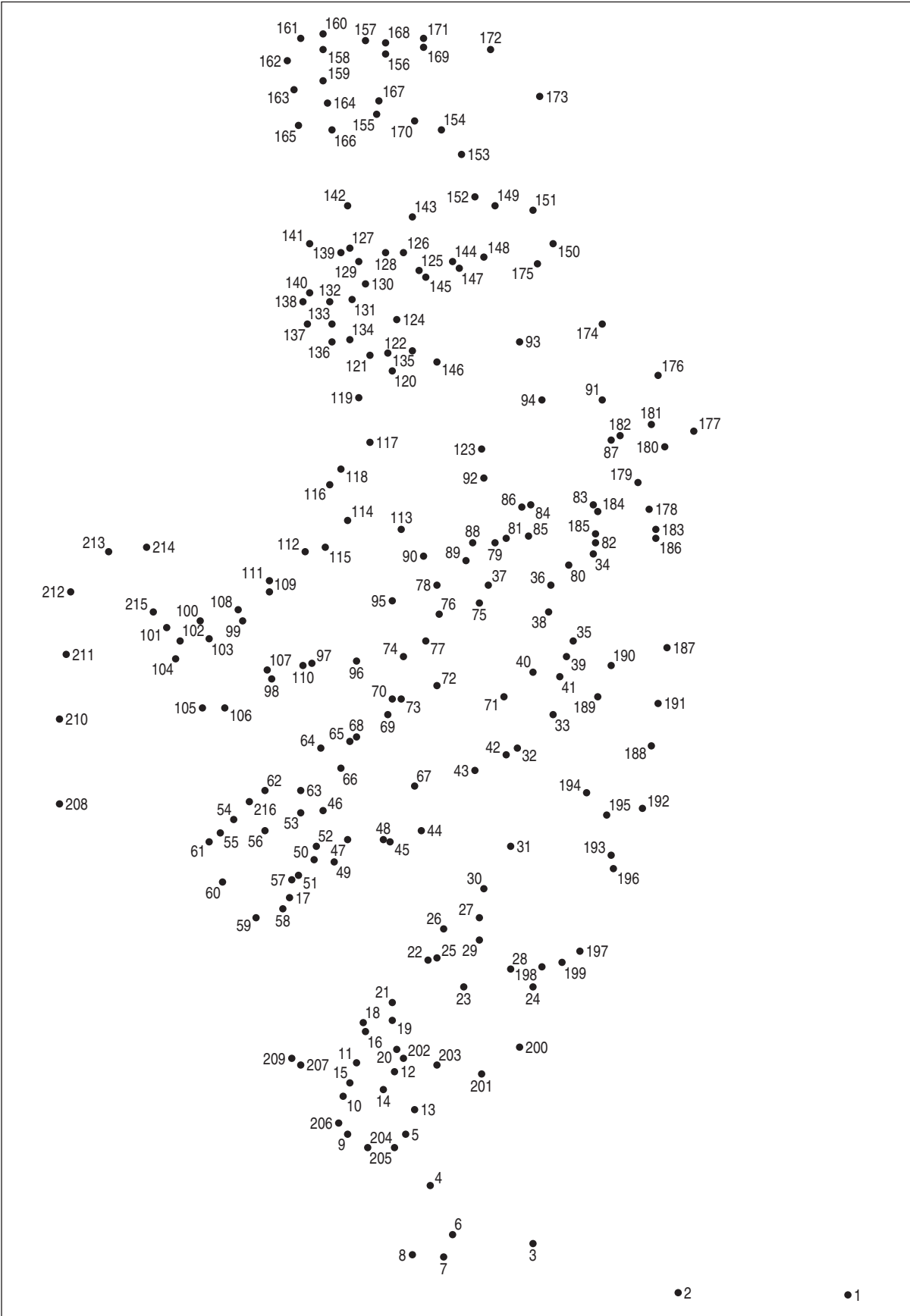

More
Conceptis Puzzles
on App Store



More
Conceptis Puzzles
on Google Play

More
Conceptis Puzzles
on conceptispuzzles.com

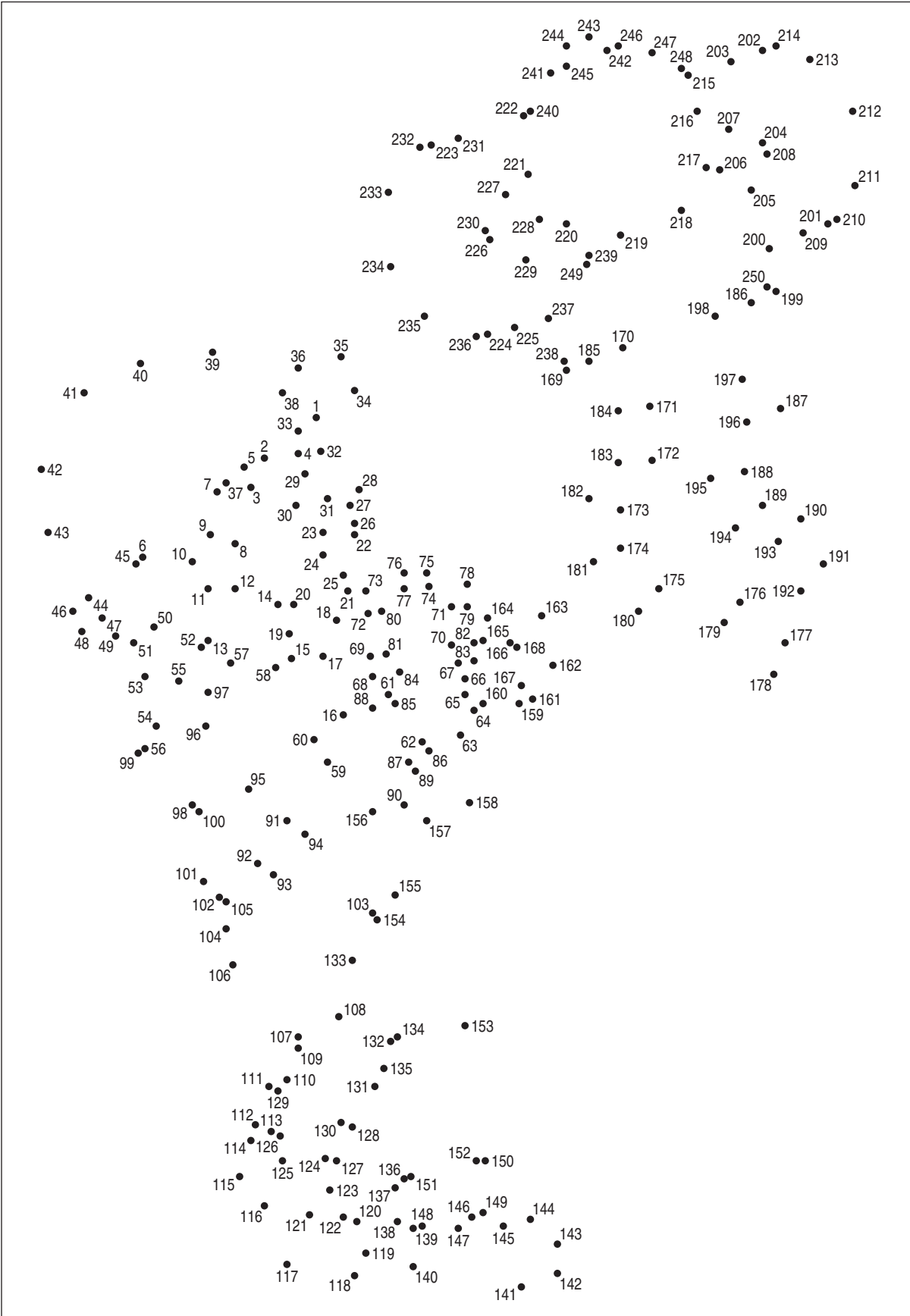

More
Conceptis Puzzles
on App Store



More
Conceptis Puzzles
on Google Play

More
Conceptis Puzzles
on conceptispuzzles.com

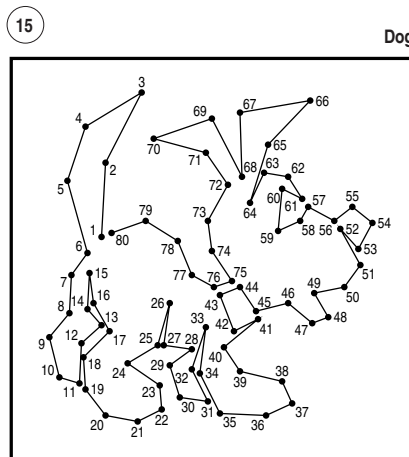
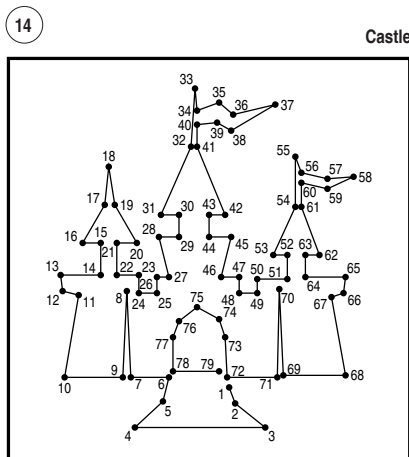
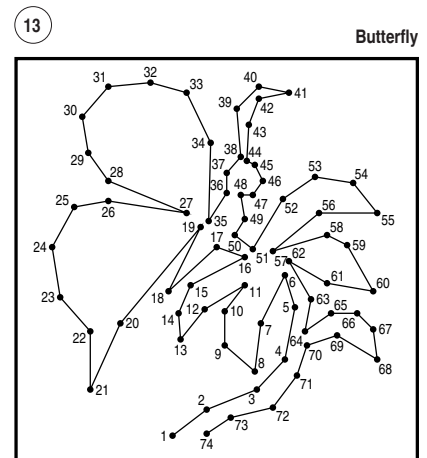
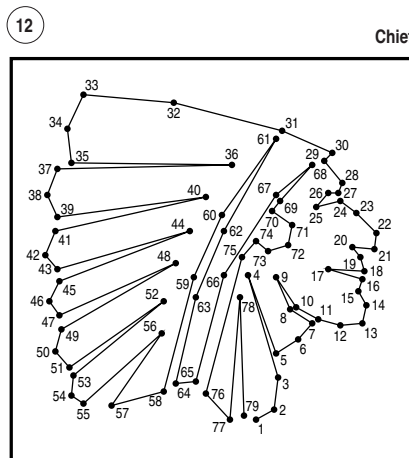
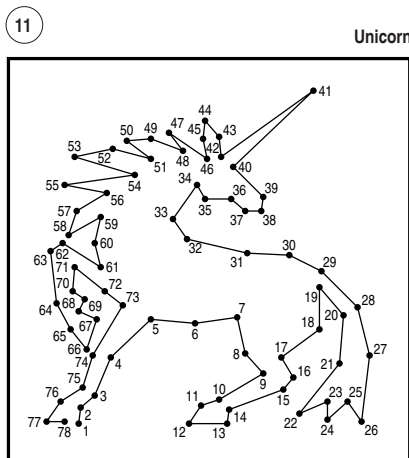
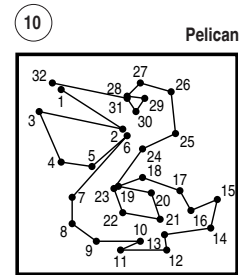
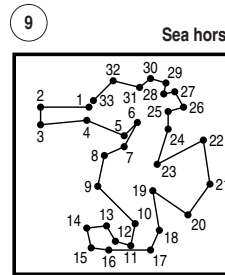
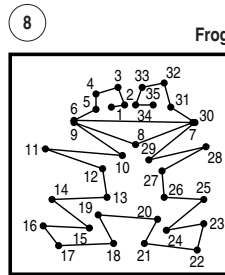
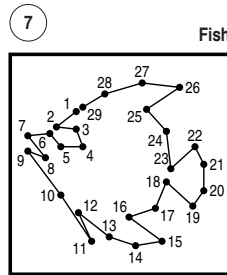
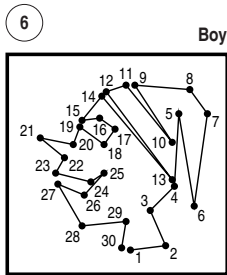
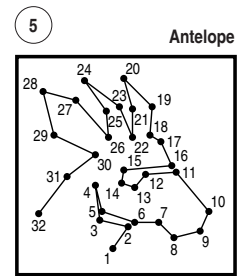
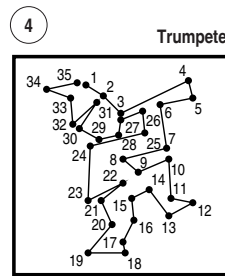
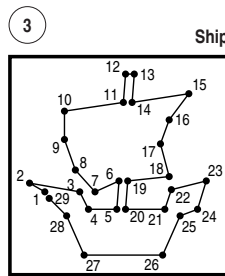
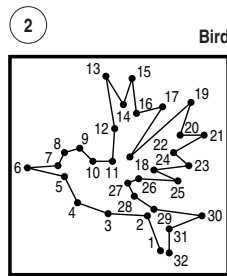
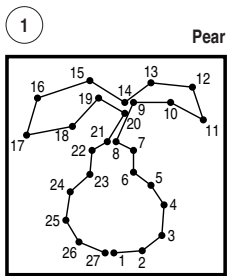

More
Conceptis Puzzles
on App Store



More
Conceptis Puzzles
on Google Play

More
Conceptis Puzzles
on conceptispuzzles.com

16

Bulldozer

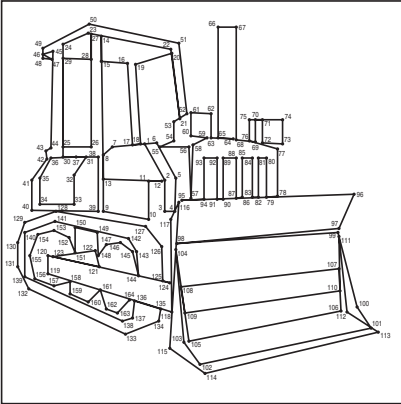

17

Playing

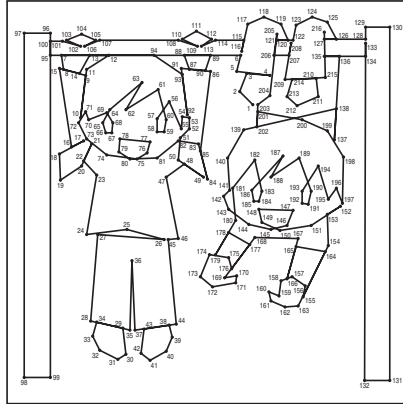

18

Nessie

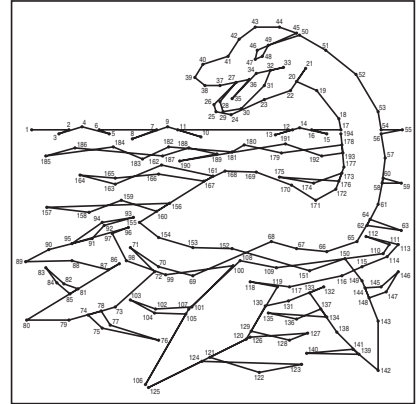

19

Darts

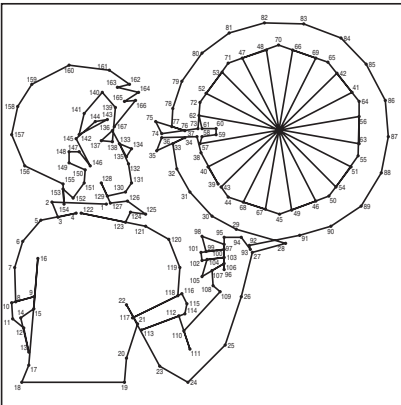

20

Elephant

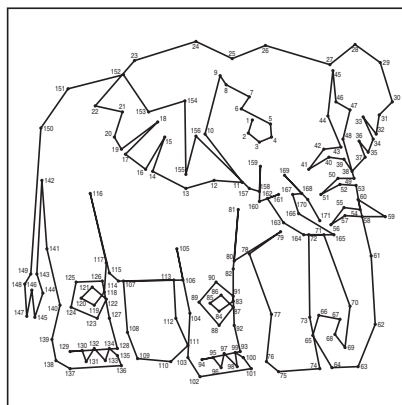

21

Dogsled

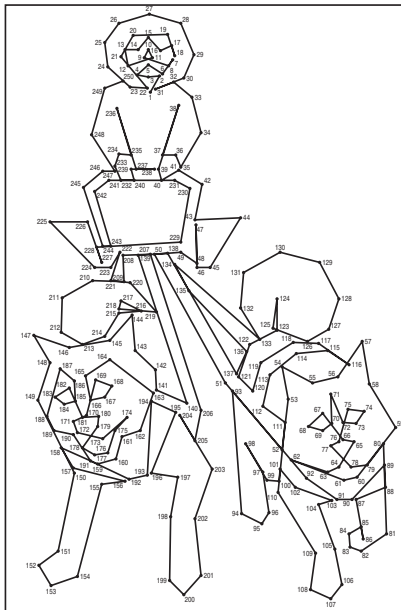

22

Bremen Town Musicians

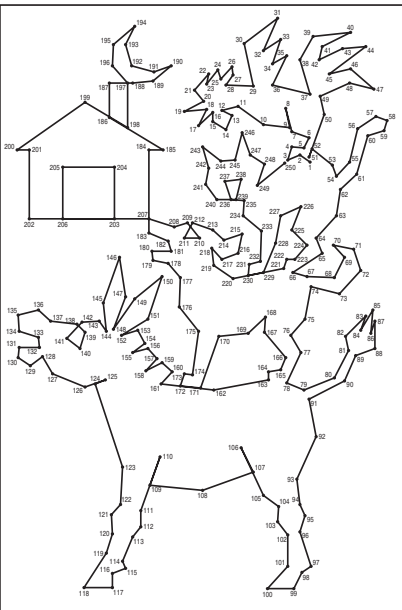

23

Jungle gym

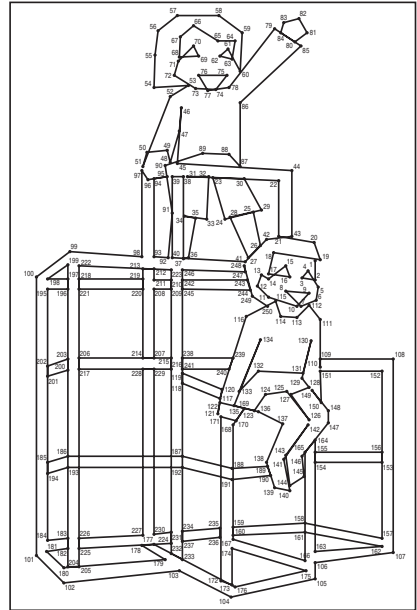

More
Conceptis Puzzles
on App Store



More
Conceptis Puzzles
on Google Play

More
Conceptis Puzzles
on conceptispuzzles.com

24

Snowboard

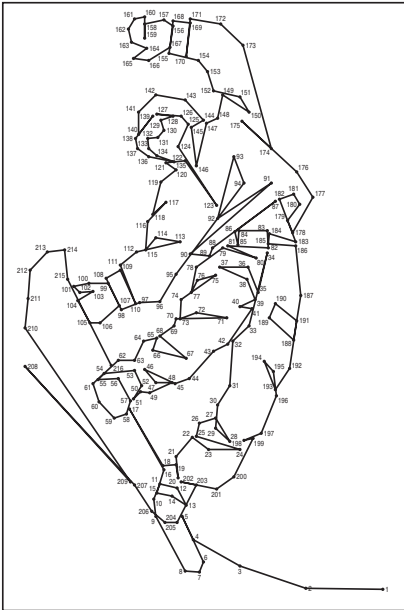

25

Kite

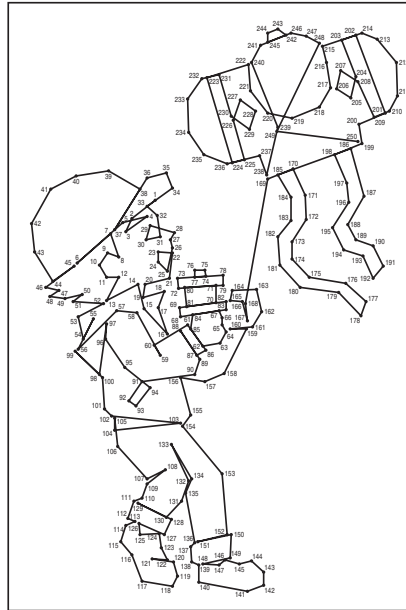

More
Conceptis Puzzles
on App Store



More
Conceptis Puzzles
on Google Play

More
Conceptis Puzzles
on conceptispuzzles.com